



MEDIFY AIR

A HIGHER STANDARD OF AIR PURIFICATION



MA-125 AIRPURIFIER

READ AND SAVE THESE INSTRUCTIONS
INSTRUCTION MANUAL AND WARRANTY INFORMATION
Lifetime warranty if replacing filters on time

MA-125/US
Rev: 04/28/23

IMPORTANT SAFETY INSTRUCTIONS:

WHEN USING ELECTRICAL PRODUCTS, ESPECIALLY WHEN CHILDREN ARE PRESENT, BASIC SAFETY PRECAUTIONS SHOULD ALWAYS BE FOLLOWED, INCLUDING THE FOLLOWING:

READ ALL OF THESE INSTRUCTIONS BEFORE USING.

WARNING — TO REDUCE THE RISK OF BURNS, FIRE, ELECTRICAL SHOCK, OR INJURY TO PERSONS:

- Before installation, maintenance, or repair, the equipment must be disconnected from the power supply.
- Do not use this product if the power cord or plug is damaged or if the plug becomes loose after plugging it in. Otherwise, this may cause an electrical shock, a short circuit, a fire, or other accidents to happen.
- Do not damage, or excessively bend, stretch, twist, bind, press, or squeeze the power cord. Otherwise, this may cause a fire, an electrical shock, a short circuit, or other accidents to occur.
- In case of a damaged power cord, replacement must be performed by a technician of the manufacturer and its maintenance department or a similar department specialist to prevent any dangerous situations.
- Only single-phase alternative current may be used. Otherwise, this may cause a fire, an electrical shock, and other accidents to happen.
- No modifications are permitted. Persons who are not maintenance technicians are not permitted to dismantle and repair this product. Otherwise, this may cause a fire, an electrical shock, or other injury to occur. Please contact the technical service center for repair services.
- For replacing filtration materials, moving, or cleaning the machine, the power must be off and the power cord must be unplugged from power sources.
- Do not connect or disconnect the power plug with wet hands, as this may cause an electrical shock and injury.
- When disconnecting the plug, the plug must be held firmly. The power cord must never be pulled, as this may cause an electrical shock, a short circuit, a fire, or other accidents to happen. If this product is not in use for a long period of time, the power plug must be disconnected. Otherwise, the insulating properties may decline and result in an electrical shock and leakage, a fire, or other accidents to occur.
- Move the air purifier to a level, flat surface to prevent it from being at an angle.
- Don't use the air purifier in highly moist conditions, as this may impair the service life of the air purifier.
- The air purifier is designed for indoor use only. Avoid any locations that may be exposed to rain, water, and outdoor conditions.
- Do not place the machine near highly humid or moist areas such as a bathroom or where a humidifier is present, as it is susceptible to moisture and doing so may cause an electrical shock or a malfunction.
- During installation, keep the space in front of the equipment clear of any obstructions for access in order to repair and maintenance the unit.
- To ensure the machine is running properly and quietly, place the equipment on a stable, level, and flat surface.

- Regularly clean dust off the plug. Accumulation of dust will result in moisture and electrical leakage, which in return may cause a fire, an electrical shock, and other accidents to happen.
- Do not use the machine in locations that produce a large quantity of oily fumes (such as the kitchen), as this may cause surface cracks.
- Do not clean with diluent for gasoline and oil paints, or spray any insecticide onto the machine, as this may cause an electrical shock, a fire, and other accidents to occur. Do not use this product after insecticide has been sprayed or used indoors.
- Keep this machine away from sparks coming from flammable gas, cigarettes, or incense. Otherwise, this may cause a fire and other serious accidents to happen.
- Do not insert any object or finger inside the air intake area or air vents, as this may cause an electrical shock and other dangerous accidents to occur.
- Please keep the filter in a sealed, air-tight bag if the air purifier is to be stored away for a prolonged period of time. Its lifespan will be reduced if it is used in an environment with high humidity. Its lifespan will also be significantly reduced if air purification is attempted in an environment with a sustained, high concentration, stable source of volatile elements.
- Supervise children when they are near the air purifier.
- Prohibited use beyond power. Can only use a 220v unit with a 220v power supply. Can only use a 110v unit with a 110v power supply. You can break or ruin the circuit boards if you plug a 110v plug into a 220v power supply.

SAVE THESE IMPORTANT INSTRUCTIONS FOR EASY REFERENCE.

UNIQUE FEATURES & SPECIFICATIONS

Medify applies innovative technologies to its air purifiers. In addition to providing highly efficient air purification, Medify completely considers the user experience, while minimizing environmental impact and energy consumption. Medify's air purifiers not only help you improve air quality in the indoor environment, but also enable you and your family members to enjoy a brand new experience. For best results, please correctly install filters by referring to the requirements under this user manual and place the equipment in an area that requires purification.

TECHNICAL DATA

- Voltage: AV120V, 60Hz
- Rated power: 110 W
- Standby Power: < 1 W
- Noise level: Max 50.2 dBA
- Room size: 63-108 sq. meters / 206-354 sq. feet
- Unit dimensions: 422 x 399 x 595 mm / 16.6 x 15.7 x 23.4 in
- Packing measurements: 510 x 485 x 685 mm / 20 x 19 x 27 in
- Unit weight: 13.8 Kg / 30.4 lbs
- Packing weight: 17 Kg / 37.5 lbs
- PM Clean Air Delivery Rate (CADR): 900m³/h

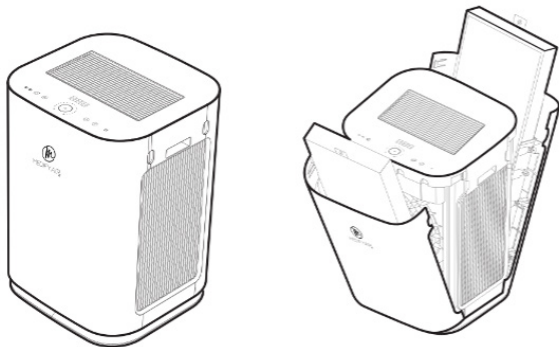

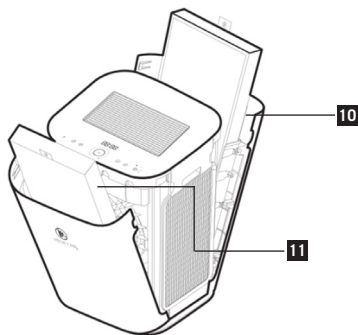
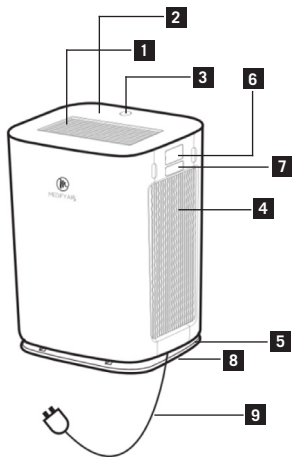

- 1 Air outlet:** Inclined-angle ventilation structure allows air flow to travel outwards.
- 2 Touch screen panel:** One touch is designed for simple and intuitive operations.
- 3 Air quality indicator:** Double display of belt and ring shapes. blue = good, amber = average, red = poor.
- 4 Side air intake:** Fluid guide vanes are durable and give an attractive look.
- 5 Lower air intake:** 3D ventilation helps air circulation.
- 6 Air quality sensor:** Monitors PM2.5 concentration.
- 7 Handle:** Built-in anti-slip assembly, makes for easy gripping.
- 8 Castor:** The 360-degree castor makes transport easier and allows for easier gripping.
- 9 Power cord:** Long enough to allow for more location options.
- 10 Open filter chamber:** Automatic power-off after it is opened makes it easy to insert and remove a single piece.
- 11 Efficient composite filter:** Its efficient low resistance contributes to the extremely long service life.

FILTER PURIFICATION

1. PRE FILTER

Removes hair, fibers, and large particles like dander.

2. TRUE HEPA H13 FILTER

The high-efficiency H13 TRUE HEPA filter is tested to removed 99.9% of particles down to 0.1 microns. This higher grade of HEPA filter easily catches pollen, dust mites, and other tiny airborne particles you can't see.

3. ACTIVATED CARBON FILTER

Substantial carbon filter with carbon pellets remove odors, and smoke.

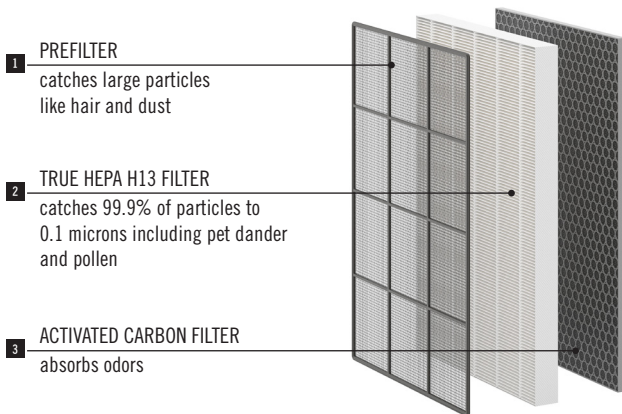

To purchase genuine Medify replacement filters, visit www.medifyair.com.

HOW TO USE & CONTROLS

BEFORE TURNING THE UNIT ON

- Ensure that filters are correctly installed to the filter chamber, that the product is placed on a flat and level surface, and that the power is well connected.
- Before the product is plugged in, first of all, make sure that the local voltage corresponds to the voltage shown on the nameplate.
- For practical needs, keep distance of at least 30 cm / 12 in all round and above the product.
- It is not recommended to get the product close to a curtain or the wall.

POWER ON

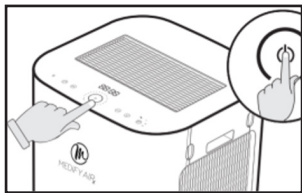

- Pressing the Power button on the control panel, and the purifier will start to operate with a prompt tone (chime). At the same time, the purifier will start in Auto mode by default.
- When the appliance is warming up, the AQI aperture of the purifier is orange, and “- - -” displays on the screen.
- You can calibrate the time by pressing the “Timer button” within 40 seconds of warming up. After 40 seconds, the purifier will display the PM2.5 level according to the current environmental quality, and the AQI aperture color will display the corresponding color according to the PM2.5 level.

FAN SPEED

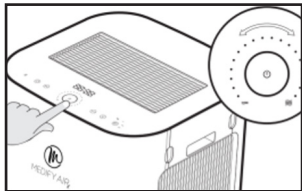

Press the button gently to adjust the speed of the air purifier. The fan has 9 different speed options.

AUTO MODE

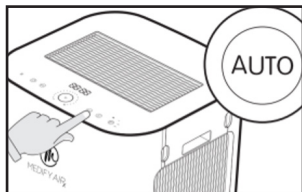

- Touch the Auto mode button to select auto. In auto mode, the appliance selects the fan speed according to the ambient air quality.

DIMMER

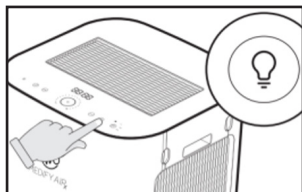

- With the light dimming button, you can switch on or off the air quality light, the display screen, and the function indicators if needed.
- Touching the light dimming button once will result in all lights being dimmed to the original 50%.
- Touch the light dimming button twice, all lights will be dimmed to the original 25%.
- Touch the light dimming button once more, the display screen and the function indicators will go off. However, the light dimming button will keep lighting.
- Touch the light dimming button for a fourth time, all lights will be turned off.
- Touch the light dimming button again, all lights will be turned on again.

UV FUNCTION

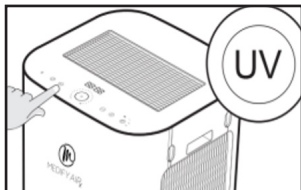

- Short pressing the UV button will start the UV mode, then the corresponding icon will light up, and the UV will start to work.
- After 30 minutes of operation, the appliance will automatically turn off the UV mode and the corresponding icon will go off.

TIMER

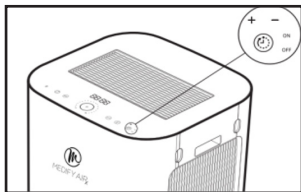

- Set Time:
 - Power on unit
 - Short press the timer button while display still shows - - : - -
 - The current time will appear with the hour blinking
 - Use the + and – keys to set the hour.
 - Short press the timer button to switch to minutes
 - Use the + and - keys to set the minute.
 - Simultaneously press + and – to set the time.
 - To view the time while the machine is on, just short press the timer button.

- Set Auto Off Time (the time at which the unit will automatically shut off)
 - While the unit is running, long press the timer button. (5 seconds)
 - The timer will start flashing and the word OFF is lit.
 - Use the + and – keys to set the hour.
 - Short press the timer button to switch to minutes
 - Use the + and – keys to set the minute.
 - Simultaneously press + and – to set the shutoff time.
 - The unit will automatically shut off at the set time.
- Set Auto On Time (the time at which the unit will automatically turn on)
 - While the unit is running, long press the timer button (5 seconds).
 - The timer will start flashing.
 - Long press the timer button (5 seconds) again until the word ON is lit.
 - Use the + and – keys to set the hour.
 - Short press the timer button to switch to minutes
 - Use the + and – keys to set the minute.
 - Simultaneously press + and – to set the turn on time.
 - Turn off the machine.
 - The unit will automatically turn on at the desired time.

Note: The shutoff timer and the auto on timer can be used simultaneously to turn the unit off at a desired interval of time and then back on again.

POWER OFF

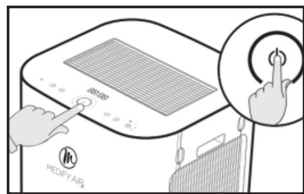

- Pressing the Power button on the control panel, and the appliance will shutdown with a prompt tone/chime.

FILTER REPLACEMENT AND MAINTENANCE

Maintenance should only be performed when the unit's power supply is turned off. The filter replacement indicator will only be visible when the light flashes.

REPLACING THE FILTER

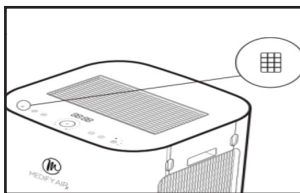

1. Check the color and code number of filter replacement indicator and verify them against the information on the packaging of the ordered filter.

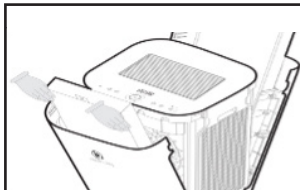

2. To remove the composite filter and then open the filter chamber. Remove the filter in accordance with the color and code number of the filter replacement indicator.

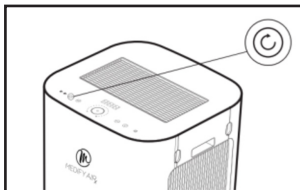

3. To insert the composite filter, remove the packaging from the filter and insert the filter in the correct direction. Shut the filter chamber door and then switch on the power supply.

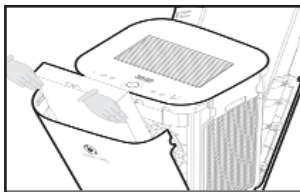

4. Shut the filter chamber and press and hold the filter maintenance confirmation button for 3 seconds while the equipment is activated to confirm.

TROUBLESHOOTING

Please refer to the troubleshooting methods below when the malfunction indicator light is on.

PROBLEM	POSSIBLE CAUSE	SOLUTION
Unit will not operate	<ul style="list-style-type: none">• It could be caused by the power supply or the filter chamber not being closed completely.	<ul style="list-style-type: none">• Check the power connection• Ensure the filter chamber is closed completely.
Reduced airflow	<ul style="list-style-type: none">• The air vents are clogged• Filters need replacing	<ul style="list-style-type: none">• Make sure side intakes or the front outflow areas are not blocked or obstructed• Replace the filters
Excessive noise	<ul style="list-style-type: none">• The equipment is placed on a rough surface• The filter is attached improperly• The plastic bag of the filter hasn't been removed yet	<ul style="list-style-type: none">• Place the equipment on a stable, level and flat surface• Check that the filter is placed correctly• Ensure that the plastic cover is removed from the filter
The indicator on the right side of the panel is on	<ul style="list-style-type: none">• The electric machine or the sensor malfunctions	<ul style="list-style-type: none">• Please call MedifyAir for technical support

If you encounter any other problem that doesn't figure on the list above, please directly call Customer Service at 888-258-1008.

WARRANTY INFORMATION

If you have any additional questions, please contact customer service. All names and trademarks are property of Medify Air. Our company reserves the right to change the product at any time, without prior notice, and the company has no obligation to adjust any products supplied earlier. Please refer to the detailed warranty terms below. To register for the lifetime warranty, please fill out the attached form and mail it to:

Medify Air

150 E. Palmetto Park Road, Suite 200
Boca Raton, Florida 33432

Or complete the lifetime warranty registration available on our website (preferred method):

www.medifyair.com

LIFETIME WARRANTY

Medify guarantees your Medify Air Purifier to be free of defects in material or workmanship for a lifetime period, provided you have completed and returned your warranty registration to Medify Air within the first 30 days of purchase, and that the filters are replaced with original and genuine Medify Air replacement filters at least once every three to four (3-4) months or after 2,500 hours of use. Within the first 30 days, Medify Air will replace the defective unit at no charge to you and reimburse you for any shipping charges. After 30 days, Medify Air's obligation and liability under this Lifetime Warranty is dependent on your use of our genuine filters, purchased on our website or from our authorized resellers, which can be found on our website. Prohibited use beyond power. Can only use a 220v unit with a 220v power supply. Can only use a 110v unit with a 110v power supply. You can break or ruin the circuit boards if you plug a 110v plug into a 220v power supply.

Our Lifetime Warranty remains in effect as long as:

1. You submit your warranty registration to Medify Air within 30 days of purchase.
2. You change filters with genuine and original Medify Air replacement filters at least once every three to four (3-4) months or after 2,500 hours of use (whichever comes first).
3. You use a proper power supply based on voltage: 110-120 V (North America & Japan) or 220-240 V (all other regions).
4. There is no evidence of tampering, mishandling, neglect, accidental damage, modification, and/or repair done to the Medify Air purifier by anyone other than authorized Medify Air service personnel.
5. Your air purifier is operated in accordance with the provided instructions.

This Lifetime Warranty is provided by:

Medify Air

150 E. Palmetto Park Road, Suite 200
Boca Raton, Florida 33432

www.medifyair.com
info@medifyair.com
(888) 258-1008

Please visit our website for
details on efficacy test data:
medifyair.com/pages/reports